

Distributed BY

JustCatering.Com Ltd

10 Jessop Avenue, Norwood Green, Middlesex, UB2 5UY, UK

Tel +44 (0)8450034271 Mobile: 07929291670

E-mail: sales@justcatering.com Web: <http://www.justcatering.com>

imc

**Technical Information
Bartender underbar system**



Contents:

Overview	Page	3
Product Care	Page	3
Drainage Information	Page	3
Designing with Bartender	Page	4-5
Key Dimensions	Page	5
Product Codes	Page	6-11
Installation Instructions	Page	12-13
Bartender Infills	Page	14

Overview

Bartender stainless steel bar workstations give you an exciting opportunity to develop dynamic, versatile and exciting underbar systems.

All Bartender units and accessories are built to the highest standards, are simple to specify and install, and can be easily reconfigured.

Product Care

The worktops and shelves must be cleaned with a damp soft cloth only. **PLEASE DO NOT USE CLEANING MATERIALS CONTAINING ABRASIVES OR BLEACHES.**

In the event of heavy soiling, a mild liquid detergent can be used.

Drainage Information

Waste Connection

Where applicable, units have 1 $\frac{1}{4}$ inch waste outlets. The waste outlets from the drainers and ice chests carry very little water and can therefore be run in pairs. Alternatively, one drainer/ice chest waste outlet can be connected to the waste outlet from a sink unit.

NOTE: Two 1 $\frac{1}{4}$ inch waste pipes can be connected into one common 1 $\frac{1}{4}$ inch pipe only when the flow of water down one is minimal. If not, they must be connected into a pipe that is at least 1 $\frac{1}{2}$ inch; e.g. two adjacent sink units.

Water Connection

Bartender taps have standard $\frac{3}{4}$ inch hot and cold connections. Where possible, fit a stopcock to each tap.

NOTE: Use PTFE tape on all connections.

Designing with Bartender

Bartender’s wide range of modules and accessories offer unlimited options of bar layout to create a solution that meets all your needs. Units are available in up to 5 different widths, giving you the flexibility to design or specify the best bar possible.

Infills

Standard 90° Corner Worktops are available with or without inset Hand Wash Basin

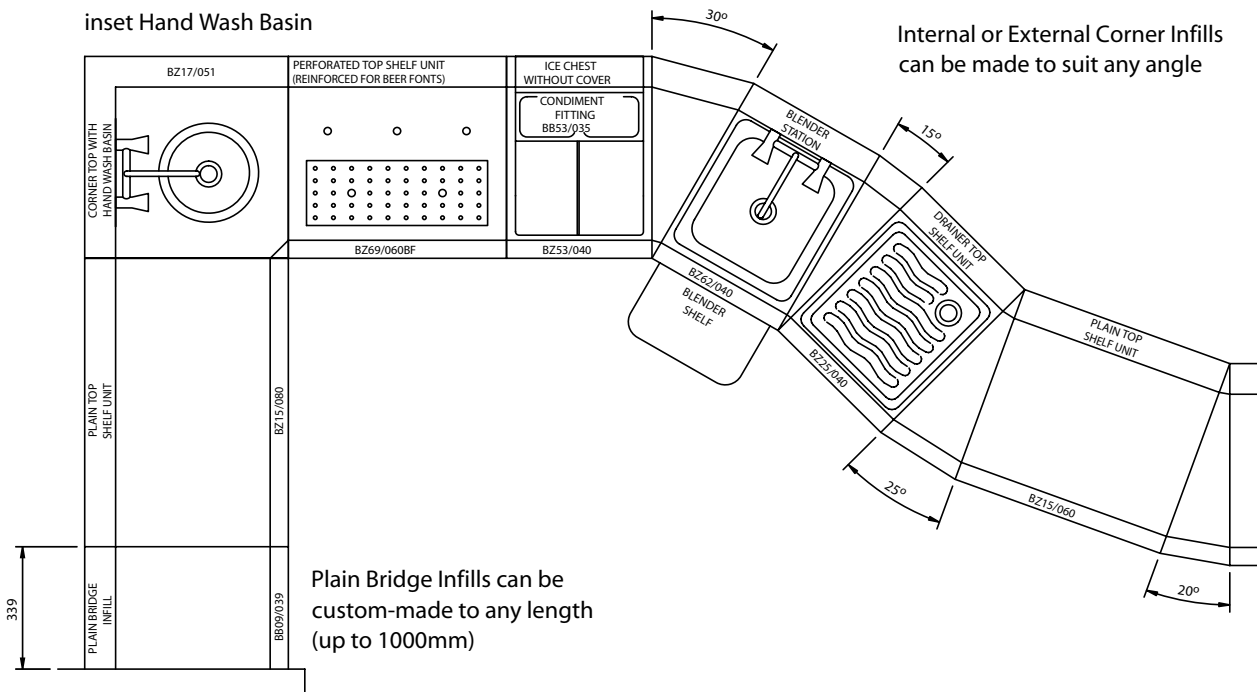

Even curved and angled bars present no problems. Standard corner worktops and custom-made infills allow a continuous bar of virtually any shape to be easily installed.

For bar projects where custom infills are required, it is recommended that these be ordered once the standard units have been installed. On-site measurement of the required lengths and angles will ensure an accurate fit and give you the best results.

A full list of Bartender Infills, including part numbers, can be found on page 14.

Bar Supports

Optional bar supports are also available. These welded steel frames support the bar top and front while leaving the under-bar space clear for the Bartender units, and creating a void for running services (beer pythons, water pipes, drainage, etc). Bar Supports are 1060mm high as standard. Other heights are available upon request.

Bar Supports requirements

- For 40mm thick timber bar tops: 1 per 1000mm of bar top
- For thicker timber tops, granite, marble, etc: 1 per 600mm of bar top

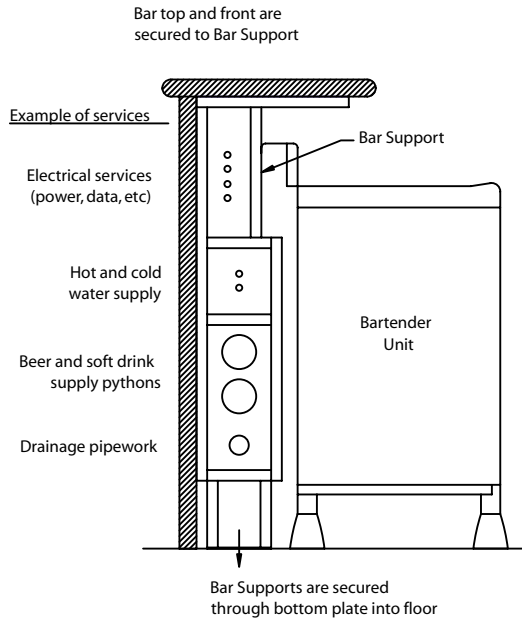

Ordering Bartender

Bartender units are supplied with one leg frame only, as adjacent units share one leg frame between them.

You will need to order extra leg frames:

- At the end of each straight run of Bartender
- Where a bridge or infill is introduced into a run

Standard leg frames are 150mm and provide an overall height of 950mm (850mm to worktop). 50mm and 100mm leg frames are also available. Please state on your order if required.



Single and Double Pole Legs should be ordered to support infills or bridging sections at the end of runs.



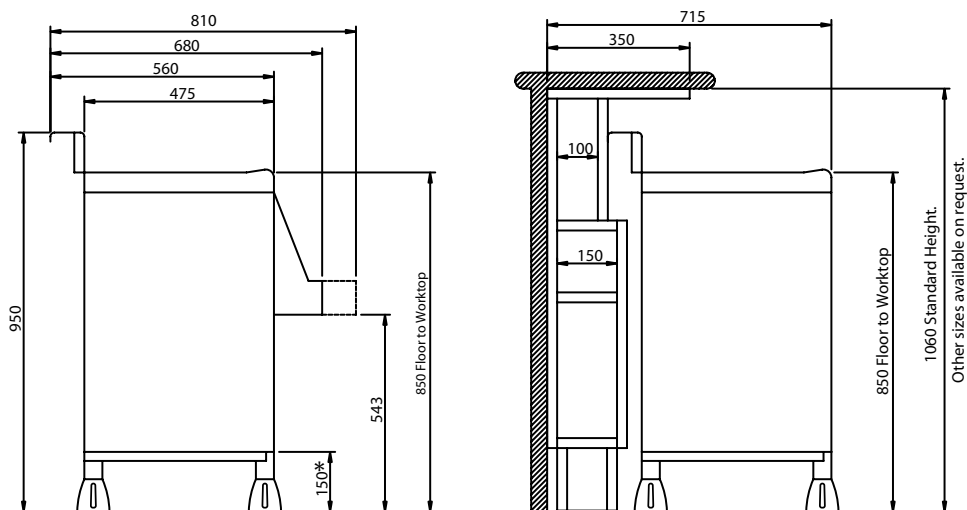

Key Dimensions:

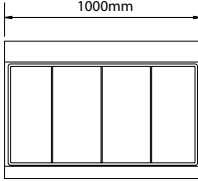
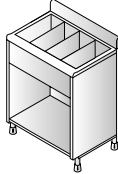
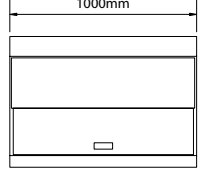
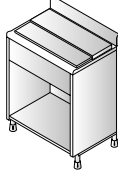
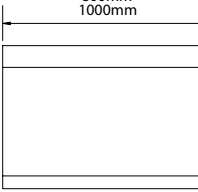
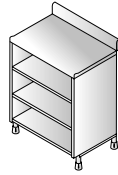
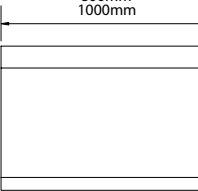
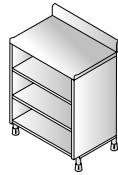
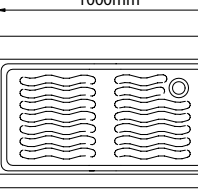
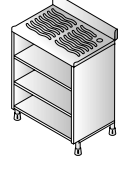
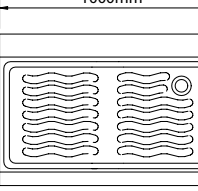
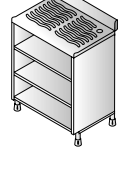
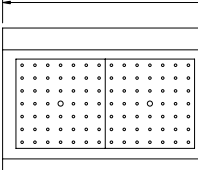



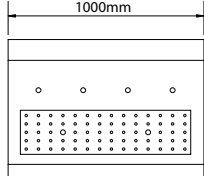

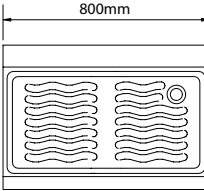
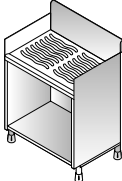
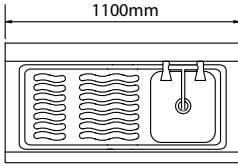
(All measurements are shown in mm)

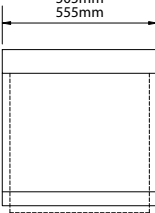
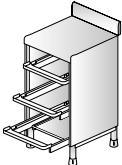
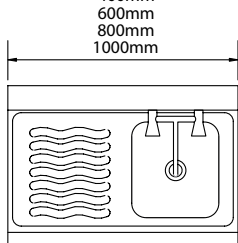
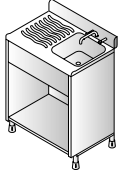
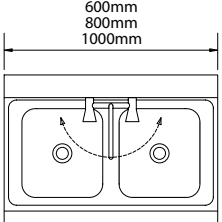
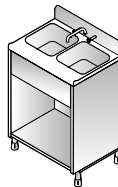
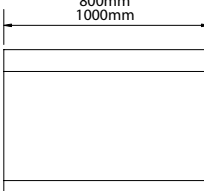
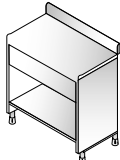

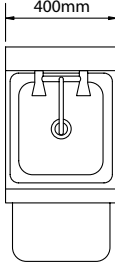

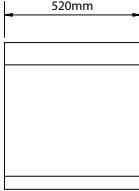
* Standard height. Other heights available on request.

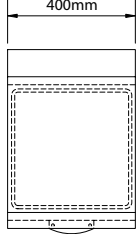
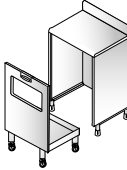
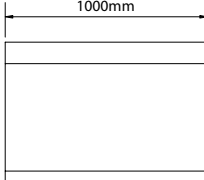
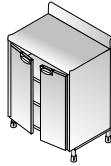
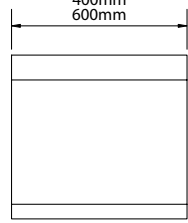
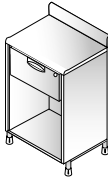
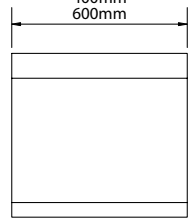

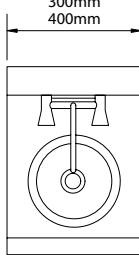
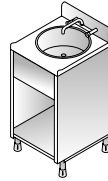

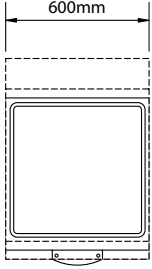
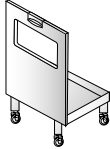
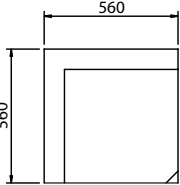
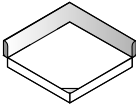
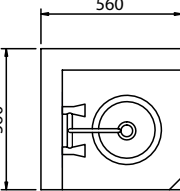
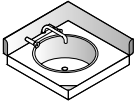
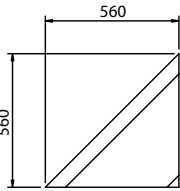
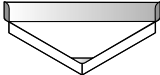
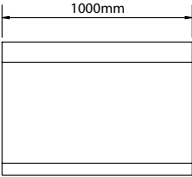
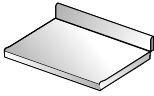
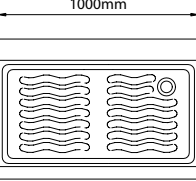
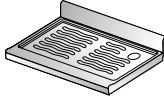

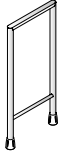
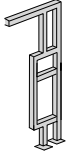
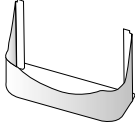
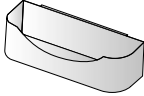
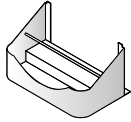
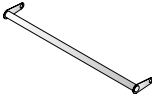
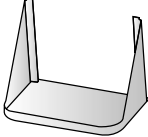

Product	Product Code	Width	
Ice Chest	BZ53/040 BZ53/060 BZ53/080 BZ53/100 Supplied complete with removable dividers, drain trays and 1 ¹ / ₄ " waste trap.	400mm 600mm 800mm 1000mm 	
Ice Chest with covers	BZ54/040 BZ54/060 BZ54/080 BZ54/100 As BZ53, but with two piece sliding covers.	400mm 600mm 800mm 1000mm 	
Shelf Unit	BZ15/040 BZ15/050 BZ15/060 BZ15/080 BZ15/100 Capacity of up to 200 pint (60cl) glasses per metre. (Stainless steel shelves)	400mm 500mm 600mm 800mm 1000mm 	
Shelf Unit	BZ37/040 BZ37/050 BZ37/060 BZ37/080 BZ37/100 Capacity of up to 200 pint (60cl) glasses per metre. (Wire shelves on support frames)	400mm 500mm 600mm 800mm 1000mm 	
Shelf Drainer	BZ25/040 BZ25/060 BZ25/080 BZ25/100 As BZ15, but with a pressed drainer top. Supplied with 1 ¹ / ₄ " waste trap. (Stainless steel shelves)	400mm 600mm 800mm 1000mm 	
Shelf Drainer	BZ38/040 BZ38/060 BZ38/080 BZ38/100 As BZ37, but with a pressed drainer top. Supplied with 1 ¹ / ₄ " waste trap. (Wire shelves on support frames)	400mm 600mm 800mm 1000mm 	
Perforated Worktop	BZ69/040 BZ69/060 BZ69/080 BZ69/100	400mm 600mm 800mm 1000mm 	

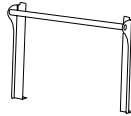
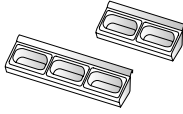
Product	Product Code	Width	
<p>Perforated Worktop</p> <p>(Reinforced top to allow mounting of beer fonts)</p>	<p>BZ69/040 BF BZ69/060 BF BZ69/080 BF BZ69/100 BF</p>	<p>400mm 600mm 800mm 1000mm</p> 	
<p>Beer Station</p> <p>Drainer is 600mm above floor, to accommodate low level beer pumps. Supplied with 1 1/4" waste trap.</p>	<p>BZ34/060 BZ34/080</p>	<p>600mm 800mm</p> 	
<p>Glasswasher Station</p>	<p>BZ63/110</p>	<p>1100mm</p> 	
<p>Basket Rack with telescopic slides</p> <p>For 400mm wide baskets BZ23/045 For 450mm wide baskets BZ23/050 For 500mm wide baskets BZ23/055</p> <p>Holds three 400, 450 or 500mm wide glasswasher baskets.</p>		<p>445mm 505mm 555mm</p> 	
<p>Single Sink</p> <p>Single Sink with door option</p> <p>BZ51/040 has no drainer, other sizes have left hand drainer. All have mixer tap and 1 1/4" waste trap. Optional door. Soap dispenser also available.</p>	<p>BZ51/040 BZ51/060 BZ51/080 BZ51/100 BZ55/040 BZ55/060</p>	<p>400mm 600mm 800mm 1000mm</p> 	
<p>Double Sink</p> <p>BZ52/060, BZ52/080 have no drainer. BZ52/100 has left hand drainer. One mixer tap set and a 1 1/4" waste trap supplied.</p>	<p>BZ52/060 BZ52/080 BZ52/100</p>	<p>600mm 800mm 1000mm</p> 	
<p>Worktop Unit</p> <p>Use instead of BZ15 shelf unit where speed rail, blender shelf or towel rail is required.</p>	<p>BZ50/040 BZ50/060 BZ50/080 BZ50/100</p>	<p>400mm 600mm 800mm 1000mm</p> 	

Product	Product Code	Width	
<p>Blender Station</p> <p>As BZ51/040 single sink fitted with blender shelf.</p>	<p>BZ62/040</p>	<p>400mm</p> 	
<p>Till Unit</p>	<p>BZ67/055</p>	<p>520mm</p> 	
<p>Waste Unit</p> <p>Wheeled waste unit supplied with bin.</p>	<p>BZ60/040</p>	<p>400mm</p> 	
<p>Storage Cupboard</p> <p>One or two door lockable cupboard with three internal shelves and worktop.</p>	<p>BZ61/040 BZ61/060 BZ61/080 BZ61/100</p>	<p>400mm 600mm 800mm 1000mm</p> 	
<p>Single Drawer Unit</p> <p>All drawers lockable individually.</p>	<p>BZ66/040 BZ66/060</p>	<p>400mm 600mm</p> 	
<p>Three Drawer Unit</p> <p>All drawers lockable individually.</p>	<p>BZ64/040 BZ64/060</p>	<p>400mm 600mm</p> 	
<p>Hand Wash Unit</p> <p>Supplied with mixer tap set and 1 1/4" waste trap. Soap dispenser also available.</p>	<p>BZ50/031 BZ50/041</p>	<p>300mm 400mm</p> 	

Product	Product Code	Width	
<p>Bottle Bin with trolley and bin</p> <p>with trolley, bin and plain bridge</p> <p>with trolley, bin and drainer bridge</p> <p>Wheeled bottle skip, with stainless steel front panel. Generally combined with plain or drainer bridge.</p>	<p>BB01/040</p> <p>BB01/060</p> <p>BZ35/040</p> <p>BZ35/060</p> <p>BZ36/040</p> <p>BZ36/060</p>	<p>400mm 600mm</p>  	
<p>Corner Top</p> <p>90° angle splash back</p> <p>To link two runs of Bartender at the worktop level.</p>	<p>BZ17/050</p>	<p>560</p> <p>560</p>  	
<p>Corner Top</p> <p>as above with wash hand basin</p> <p>As BZ17/050 but fitted with BB63/001 wash hand basin. Soap dispenser also available.</p>	<p>BZ17/051</p>	<p>560</p> <p>560</p>  	
<p>Corner Top</p> <p>45° angle splash back</p> <p>For use where the bar structure is curved. Non-standard infills available.</p>	<p>BZ17/052</p>	<p>560</p> <p>560</p>  	
<p>Plain Bridge</p>	<p>BZ09/040</p> <p>BZ09/060</p> <p>BZ09/080</p> <p>BZ09/100</p>	<p>400mm 600mm 800mm 1000mm</p>  	
<p>Drainer Bridge</p>	<p>BZ08/040</p> <p>BZ08/060</p> <p>BZ08/080</p> <p>BZ08/100</p>	<p>400mm 600mm 800mm 1000mm</p>  	
<p>Leg Frame</p> <p>Units are supplied with one leg frame only, as adjacent units share one frame between them. Extra frames may be required:</p> <ul style="list-style-type: none"> - at the end of each straight run of Bartender - where a bridge is introduced into a run 	<p>BB02/208</p> <p>BB02/108</p> <p>BB02/008</p>	<p>150mm high</p> <p>100mm high</p> <p>50mm high</p> 	

Product	Width (mm)	Product Code	
Single Pole Leg Supports infill or bridging section at end of run.		BB02/211	
Double Pole Leg Supports infill or bridging section at end of run.		BB02/210	
Painted Steel Bar Support 1060mm high, standard. Other heights to order		BB70/001	
Speed Rail Used on ice chests, sinks and worktops.	400 600 800 1000	BB52/040 BB52/060 BB52/080 BB52/100	
Add-on Speed Rail Attached to front of BB52 to double capacity.	400 600 800 1000	BB57/040 BB57/060 BB57/080 BB57/100	
Double Speed Rail	400 600 800 1000	BB69/040 BB69/060 BB69/080 BB69/100	
Speed Rail Lock Used on single and double speed rails.	400 600 800 1000	BB68/040 BB68/060 BB68/080 BB68/100	
Blender Shelf 210mm deep 230mm deep Used on sinks, ice chest, corner units or worktops.	400 600 400 600	BB51/040 BB51/060 BB51/043 BB51/063	

Product	Width (mm)	Product Code	
Towel Rail	400 600 800 1000	BB50/040 BB50/060 BB50/080 BB50/100	
Used on sinks, hand wash units, corner units, worktops and ice chests.			
Condiment Set			
2 x 1/9 x 65mm GN containers	350	BB53/035	
3 x 1/9 x 65mm GN containers	525	BF67/052	
Hangs on splashback.			
Wash Hand Basin	305mm Ø	BB63/001	
Can be inset into worktops, plain bridges or custom made infills. Supplied with mixer tap set and 1 1/4" waste trap.			
Bottle Opener		BB55/001	
Can be fitted to ice chests, sinks or worktops. Includes catcher.			
Single Trim		BB71/001	
To be attached to the end unit in a run of Bartender.			
Double Trim		BB71/002	
To join two adjacent Bartender units in a straight run.			
Corner Trim		BB71/003	
To join two adjacent Bartender units at an angle.			
Soap Dispenser		BB64/001	
Pre-fitted on request. For inserting into hand wash unit. <i>(Please specify location at time of order)</i>			
Fresh Water Dispenser		BB66/001	
Decor Panel		BB56/001	
Polished stainless steel decor panels provide a clean finish at the end of a run.			

Installation Instructions

a) Unpack the units and make sure that nothing has been damaged during transit.

b) Remove transit strip from the front of the unit.

c) Place two leg frames on the floor.

d) Position unit onto the leg frames ensuring that the back straight edge of leg plate is flush with the back of the unit.

e) With the unit positioned on leg frames, secure the two together with M5 x 12 screws (2 off to each side). N.B. Use M5 x 50 screws (D21/110) for Basket Rack units.

D21/044
4 x M5 SCREW

TRANSIT STRIP

BB02/208
(ADJUSTABLE LEG)

Note: Two units together share a leg frame

1 IDENTIFY FIRST UNIT AND ATTACH LEG FRAMES

a) Attach a leg frame to support the other end of the unit, using the same method as described in stage 1

b) Insert 2 x Dowel Pins into the threaded holes in the side of both worktops as indicated

c) Attach the adjacent unit by locating it onto the shared leg frame and securing with 2 x M5 x 12 screws. Ensure that the dowel pins on the side of the worktops locate into their respective holes

d) Follow the same procedure to attach the other units

DOWEL PIN

SHARED LEG FRAME

2 MATE WITH ADJACENT UNIT

a) Fit shelves inside the units by locating the 4 tabs on the side of the shelf into the bridge forms on both side panels

NOTE: The bottom shelf for 800 and 1000mm wide Cupboard Units should be fitted first before attaching the adjacent unit. Detach one of the doors by undoing the screws on the hinges. Remove the 4 screws securing the hinge brackets and fit the bottom shelf. Reassemble the bracket and the door.

b) Fit the front trims to the units by tilting at an angle and locating the top tabs to the underside of the worktop. With the tabs located inside the worktop, push the trim until it grips the front returns on the side panels. Ensure that the bottom holes are aligned and secure with the plastic fasteners.
* (See enlarged detail)

* FITTING FRONT TRIMS

BB70/001
(SINGLE FRONT TRIM)

D28/045
(PLASTIC FASTENERS)

BB71/001
(DOUBLE FRONT TRIM)

4 FIT SHELVES AND TRIMS

Installation Instructions

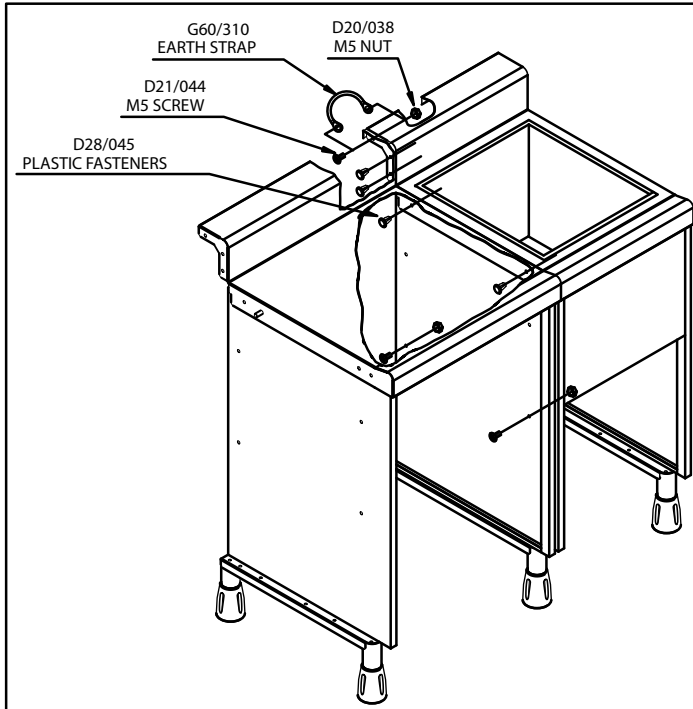

- a) Secure the units together with the push-fit plastic fasteners and the M5 screws and nuts as indicated
- b) Use an M5 screw and nut to secure the earth strap to both unit at the splash back
- c) Follow the same procedure to attach the other units
- d) Fit bottom shelf to each unit as units are added and secured

BRIDGE AND INFILLS

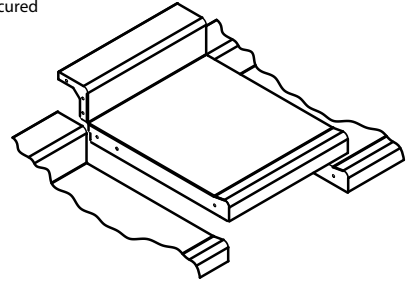

- Remove the locating pins from the worktop of the adjoining units.
- Slide bridge worktop or infill between the two units, ensuring that all edges and holes are aligned.
- Secure with the plastic fasteners or the M5 screws provided.

3 SECURE TO ADJACENT UNIT

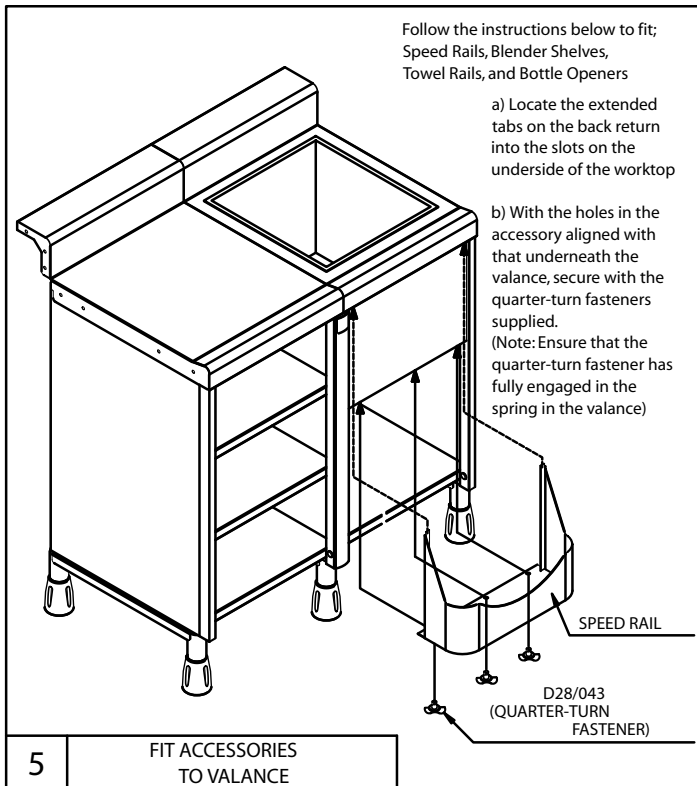

Follow the instructions below to fit; Speed Rails, Blender Shelves, Towel Rails, and Bottle Openers

- a) Locate the extended tabs on the back return into the slots on the underside of the worktop
- b) With the holes in the accessory aligned with that underneath the valance, secure with the quarter-turn fasteners supplied. (Note: Ensure that the quarter-turn fastener has fully engaged in the spring in the valance)

5 FIT ACCESSORIES TO VALANCE

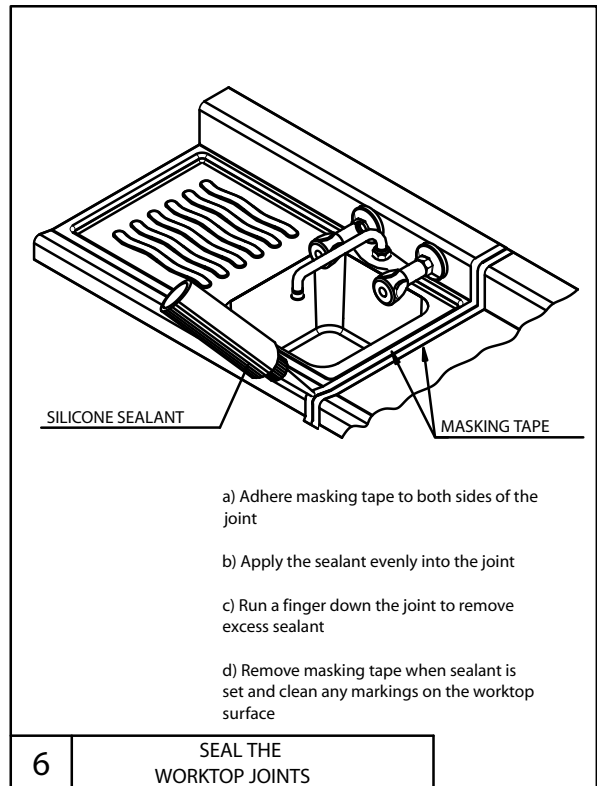

- a) Adhere masking tape to both sides of the joint
- b) Apply the sealant evenly into the joint
- c) Run a finger down the joint to remove excess sealant
- d) Remove masking tape when sealant is set and clean any markings on the worktop surface

6 SEAL THE WORKTOP JOINTS

Bartender Infills:

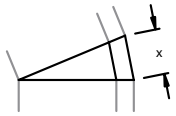
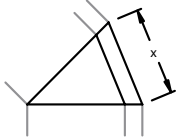
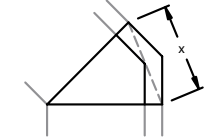
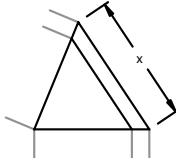
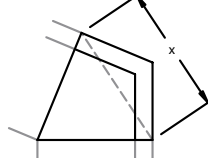
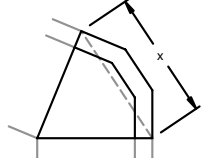
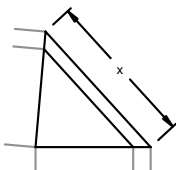
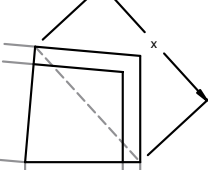
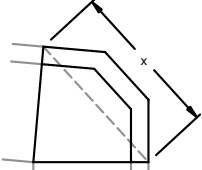
Description	Single Splashback	Double Splashback	Triple Splashback						
5° - 22° Corner Infill (70mm < x < 220mm)									
				Internal	BB17/022 S				
				External	BB18/022 S				
23° - 45° Corner Infill (220mm < x < 430mm)									
				Internal	BB17/045 S	Internal	BB17/045 D		
				External	BB18/045 S	External	BB18/045 D		
46° - 67° Corner Infill (430mm < x < 620mm)									
				Internal	BB17/067 S	Internal	BB17/067 D	Internal	BB17/067 T
				External	BB18/067 S	External	BB18/067 D	External	BB18/067 T
68° - 89° Corner Infill (620mm < x < 790mm)									
				Internal	BB17/089 S	Internal	BB17/089 D	Internal	BB17/089 T
				External	BB18/089 S	External	BB18/089 D	External	BB18/089 T

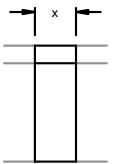
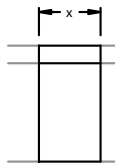
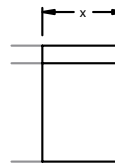
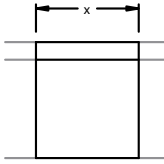
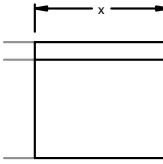
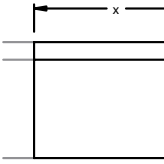
Description	50mm < x < 99mm	100mm < x < 199mm	200mm < x < 399mm
Plain Bridge Infill			
	BB09/009	BB09/019	BB09/039
Plain Bridge Infill			
	BB09/059	BB09/079	BB09/099